

Over Sampling Digital Filter LSI

Description

The CXD1162P is a digital filter LSI with quadrupled sampling rate, developed for compact disc player.

Features

- 83 taps and 21 taps filters linked through cascade connections provide a quadrupled sampling digital filter.
- Built-in filters for 2 channels correspond to L and R.
- A variety of functions, including soft muting.
- 83rd and 21st order filters have 2 modes of filter coefficients each, that enable the selection of the filter characteristics most suitable for usage.

Function

- Built-in filters for 2 channels
- Filtering with a quadrupled sampling rate
- 2-stage FIR filters interconnected in cascade (83 taps+21 taps)
- Soft-muting function
- Independent linear interpolation for either L or R, up to 8 words.
- 2 modes of coefficients provided for both 83 taps and 21 taps (See the Filter Characteristics)
- Input/Output format
 - Input: 2's complement MSB first (serial)
 - Output: 2's complement MSB first (serial)

Structure

Silicon gate CMOS IC

Absolute Maximum Ratings (Ta=-20 to +75°C)

• Supply voltage	V _{DD}	-0.5 to +6.5	V
• Input voltage	V _I	-0.5 to V _{DD} +0.5	V
• Allowable power dissipation	P _D	550	mW (Ta=75°C)
• Storage temperature	T _{stg}	-55 to +150	°C

Recommended Operating Conditions

• Supply voltage	V _{DD}	4.5 to 5.5	V
• Operating temperature	T _{opr}	-20 to +75	°C
• OSC frequency	f _x	10 to 20	MHz

Package Outline

Unit: mm

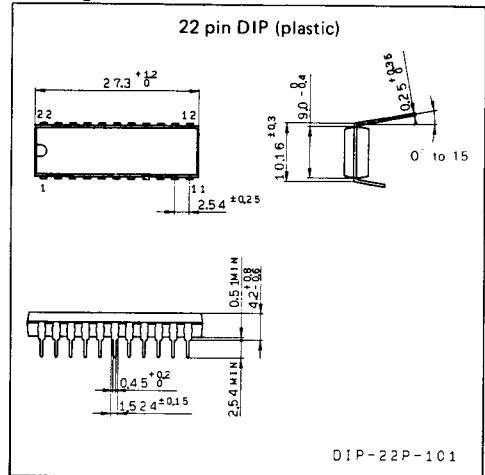

Block Diagram

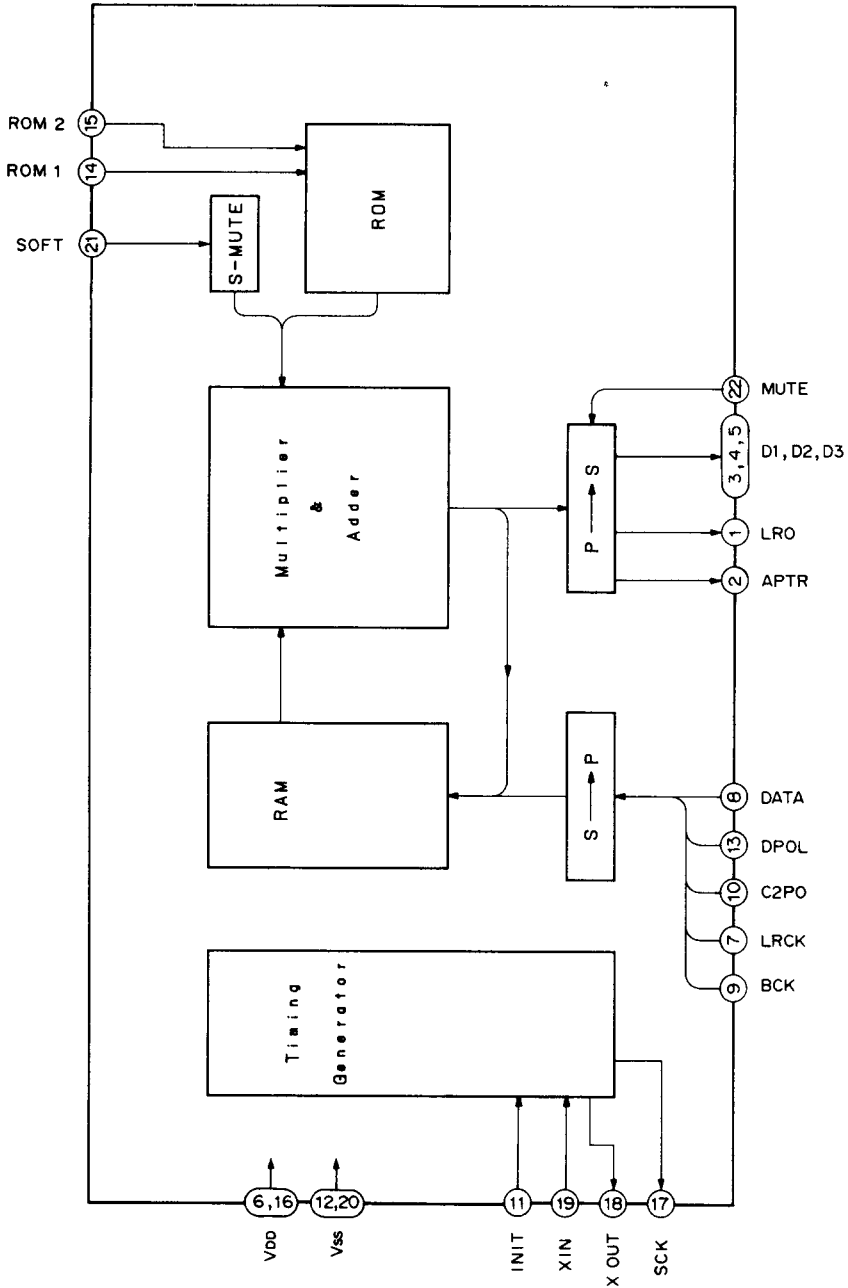

Pin Configuration and Description (Top View)

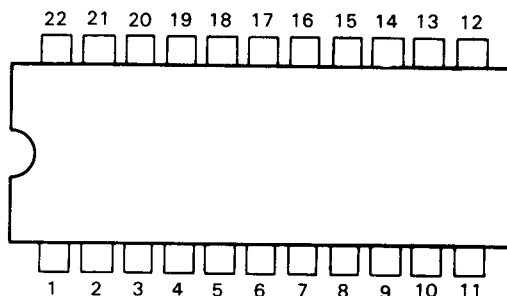

No.	Symbol	I/O	Description
1	LRO	O	LRCK output (4fs)
2	APTR	O	Aperture clock for R aperture
3	D ₁	O	BCK output (4fs)
4	D ₂	O	DATA output (4fs)
5	D ₃	O	WCK output
6	V _{DD}	–	Positive supply (+5V)
7	LRCK	I	LRCK input
8	DATA	I	16 bit 2 serial data input 2's complement
9	BCK	I	BCK input
10	C2PO	I	Error flag input
11	INIT	I	Power on reset input. Active at "L"
12	V _{SS}	–	Negative supply (0V)
13	DPOL	I	Reverses input data polarity
14	ROM1	I	ROM switching for 83rd order(See the Filter Characteristics)
15	ROM2	I	ROM switching for 21st order(See the Filter Characteristics)
16	V _{DD}	–	Positive supply (+5V)
17	SCK	O	System clock output for external IC (384fs)
18	XOUT	O	Output of crystal oscillation circuit (384fs)
19	XIN	I	Input of crystal oscillation circuit (384fs)
20	V _{SS}	I	Negative supply (0V)
21	SOFT	I	Soft muting ON/OFF switch. On at "H" level
22	MUTE	I	"H" level

Electrical Characteristics

DC characteristics

V_{DD}=4.5 to 5.5V, T_a=-20 to +75°C

No.	Item	Symbol	Condition	Min.	Typ.	Max.	Unit
19 XIN	Input leak current	I _{LI}	V _I =V _{DD} /OV	-	-	±20	μA
All inputs	"H" input voltage	V _{IH}	-	0.76V _{DD}	-	-	V
	"L" input voltage	V _{IL}	-	-	-	0.24V _{DD}	
	Input leak current	I _{LI}	V _I =V _{DD} /OV	-	-	±5	μA
	Input capacity	C _{IN}	-	-	4	6	PF
1 LRO 2 APTR 4 D1 4 D2 5 D3	"H" output voltage	V _{OH}	I _O =-4 mA	V _{DD} -0.5	-	-	V
	"L" output voltage	V _{OL}	I _O =4 mA	-	-	0.4	
17 SCK	"H" output voltage	V _{OH}	I _O =-5 mA	V _{DD} -1.0	-	-	V
	"L" output voltage	V _{OL}	I _O =5 mA	-	-	1.0	
	Current consumption	I _{DD}	Unload V _I =V _{DD} /OV f _X =16.93 MHz	-	-	40	mA

AC characteristics

V_{DD}=4.5 to 5.5V, T_a=-20 to +75°C

Item	Symbol	Condition	Min.	Typ.	Max.	Unit
Oscillating frequency	f _X t		-	16.9344	20.0	MHz
Input BCK frequency	f _{BCK}	f _{XT} =16.9344 MHz C _L =50 pF	-	-	3.5	MHz
Input BCK pulse width	t _{WIB}		100	-	-	ns
Input data set-up time	t _{IDS}		20	-	-	ns
Input data hold time	t _{IDH}		20	-	-	ns
Input LRCK set-up time	t _{ILRS}		50	-	-	ns
Input LRCK hold time	t _{ILRH}		50	-	-	ns
Output BCK pulse width	t _{WOB}		45	-	-	ns
Output data set-up time	t _{ODS}		30	-	-	ns
Output data hold time	t _{ODH}	40	-	-	ns	

AC characteristics

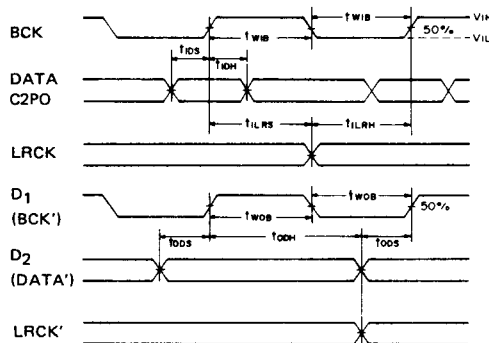

Description of Functions

1. Soft muting

Mutes or de-mutes output data within approximately 46 mS (2048/fs).

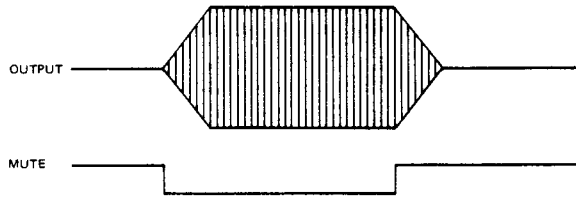

Fig. 1

2. Muting

When MUTE goes high or INIT goes low, the output is muted.

3. Data polarity

Allows switching between inversion and non-inversion of output data.

When DPOL level is "H", the output data is inverted with respect to the input data.

4. Interpolation

Error in an input data block consisting of up to eight consecutive data units can be linearly interpolated by two correct data units, namely, the one preceding the erroneous block and the one following it. (This is done separately for L and R.) For errors of more than eight consecutive input data units, only the last eight data are linearly corrected, and all preceding data units are maintained without correction.

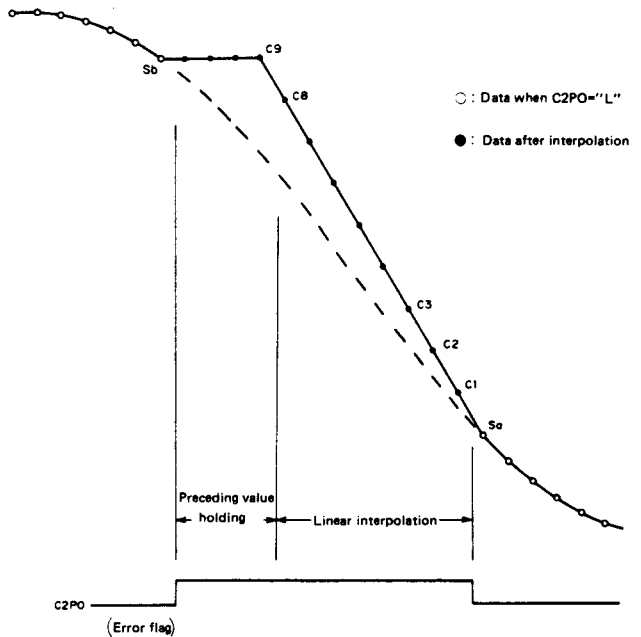

5. Input and output

1) Input

The changeover point of MSB first serial data (f_s) of 2's complement represents the switching of LRCK of this data string, only the data of the last 16-bit clock (BCK) are valid.

When INIT="L" (resetting), the input data are invalid and the input is equivalent to ALL "0".

2) Output

MSB first serial data ($4f_s$) of 2's complement clock pulses such as LRO and BCK are output only when resetting is canceled (INIT="H") and MUTE="L". Otherwise, muting remains effective.

Filter Characteristics

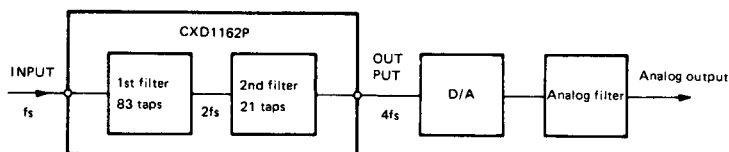

Input spectrum

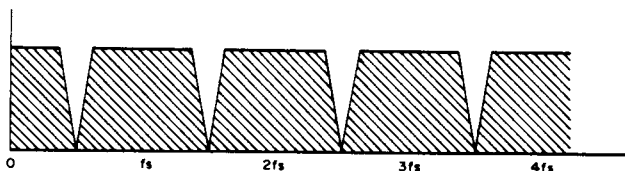

Characteristics of 1st filter

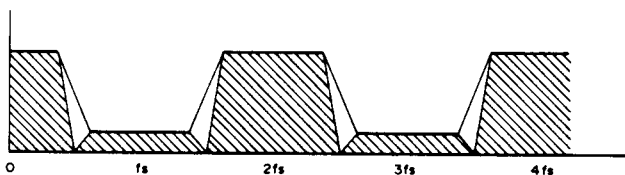

Characteristics of 2nd filter

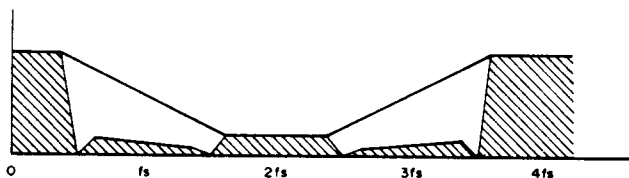

Characteristics of analog filter

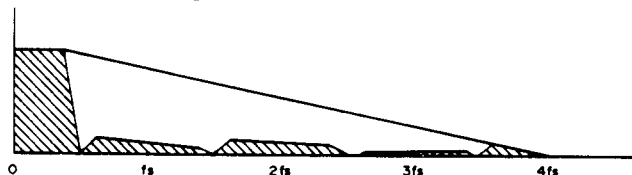

I/O Timing Chart

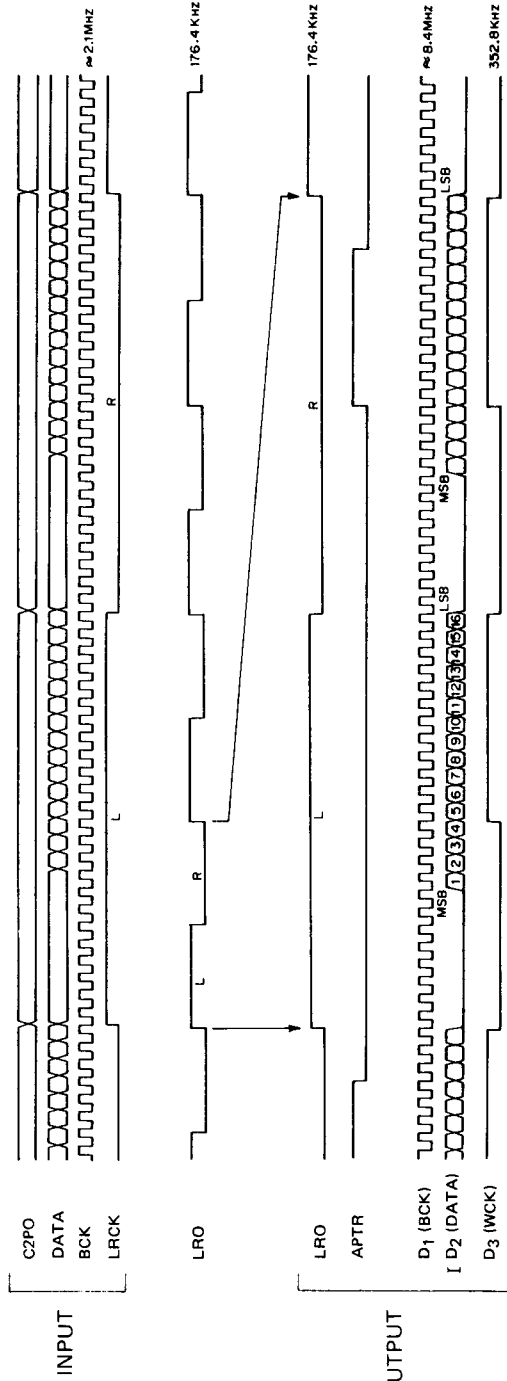

Combined Filter Characteristics (1st filter+2nd filter)

1) ROM1="H"

Stop band attenuation: 80 dB Min. (over 25.7 kHz)

Pass band ripple: 0.001 dB Max.

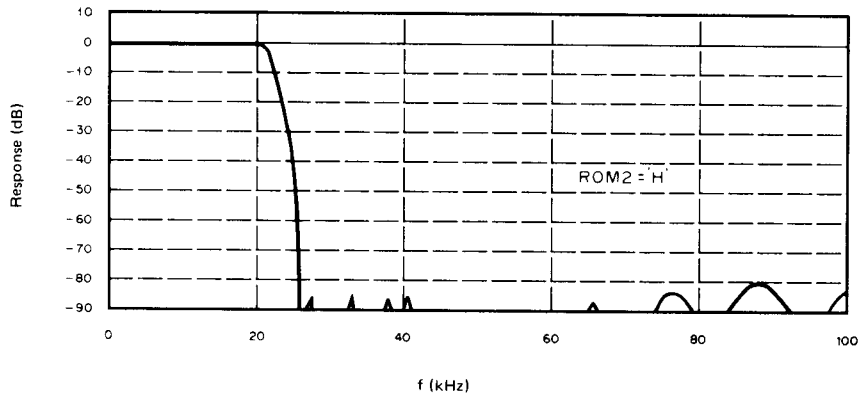

2) ROM1="L"

Stop band attenuation: 60 dB Min. (24.1 kHz); 65 dB Min.

Pass band ripple: 0.004 dB Max.

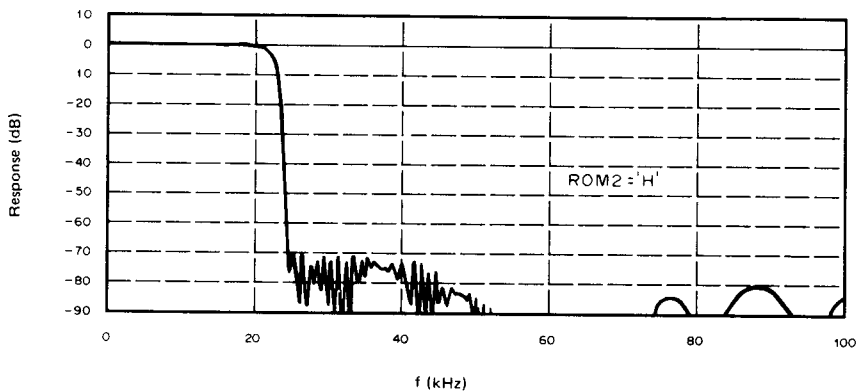

Filter Characteristics-1

1st Filter+(83 taps ROM1="H")

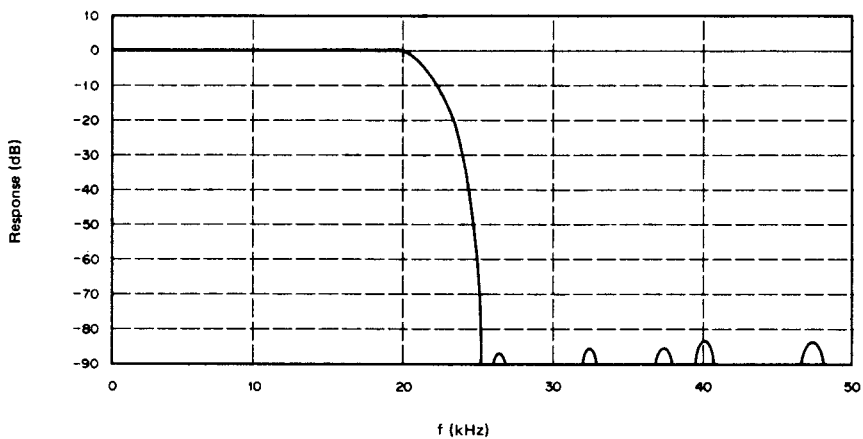

Filter frequency characteristics

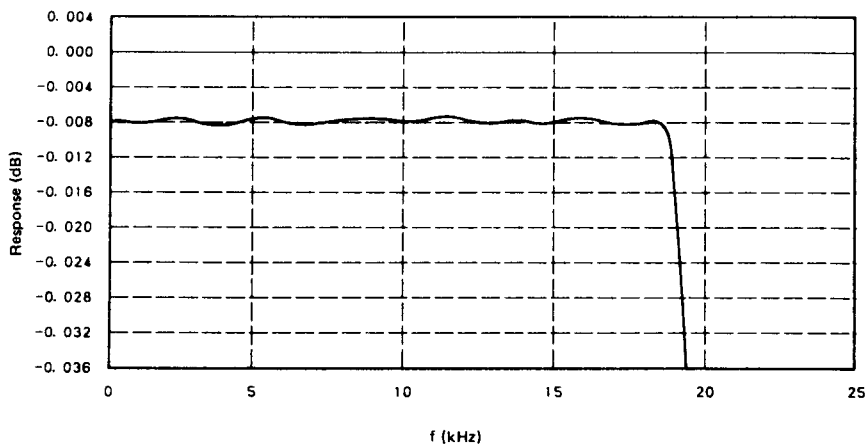

Pass band ripple characteristics

Filter Characteristics-2

1st Filter (83 taps ROM1="L")

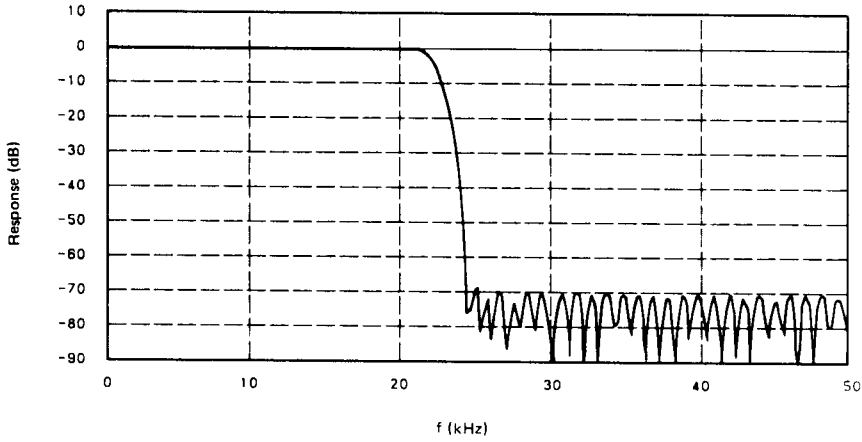

Filter frequency characteristics

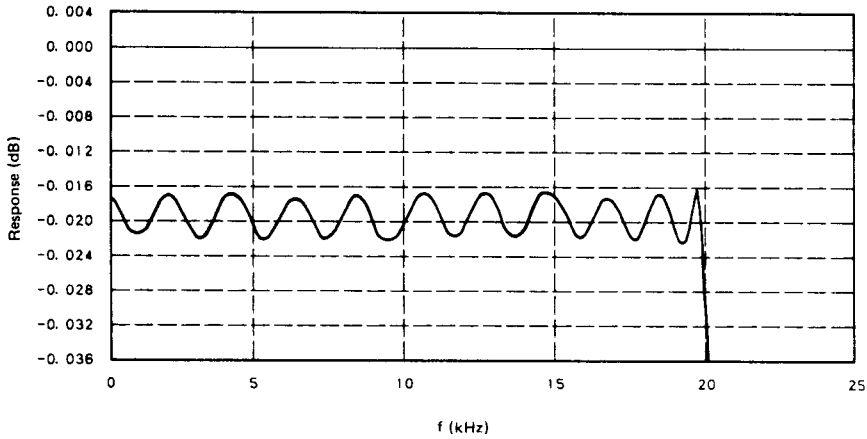

Pass band ripple characteristics

Filter Characteristics-3

2nd filter (21 taps, ROM2="H")

- Pass band flat (without frequency characteristics compensation)

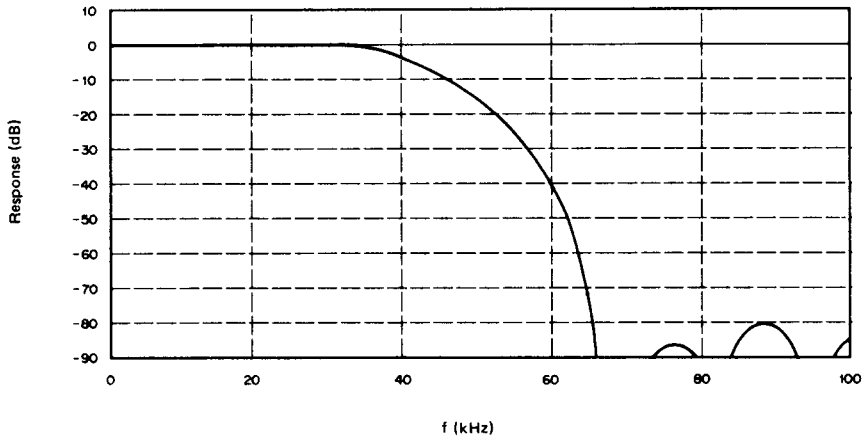

Filter frequency characteristics

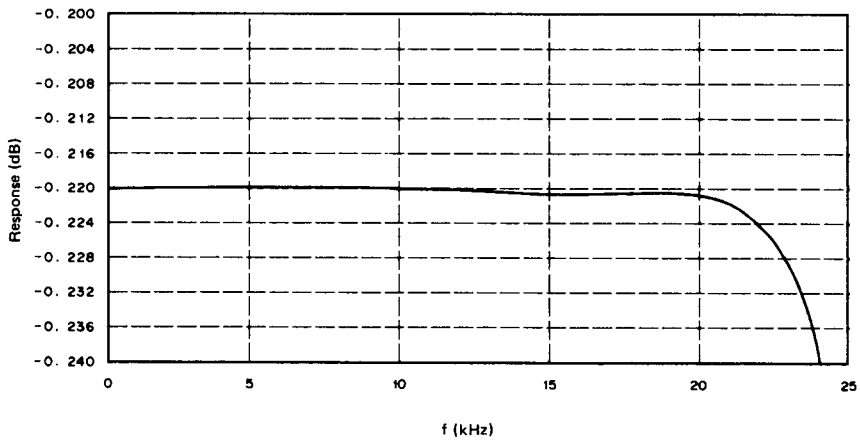

Pass band ripple characteristics

Filter Characteristics-4

2nd filter (21 taps, ROM2="L")

- Pass band frequency characteristics (compensation of aperture effect and analog 3rd order Bessel filter characteristics)

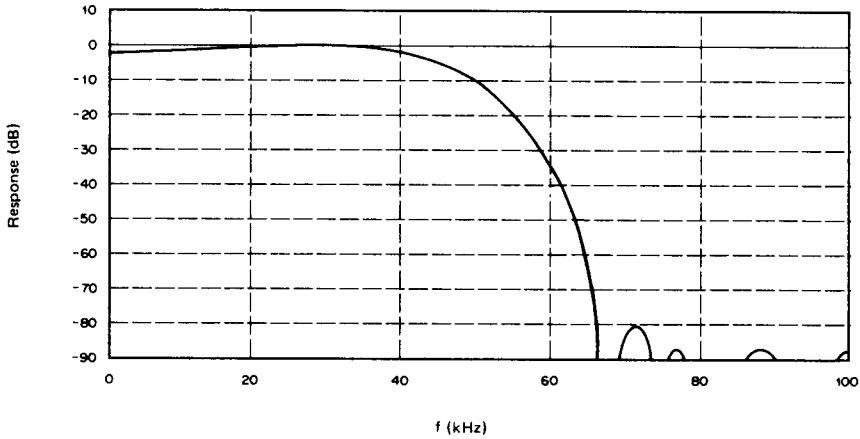

Filter frequency characteristics

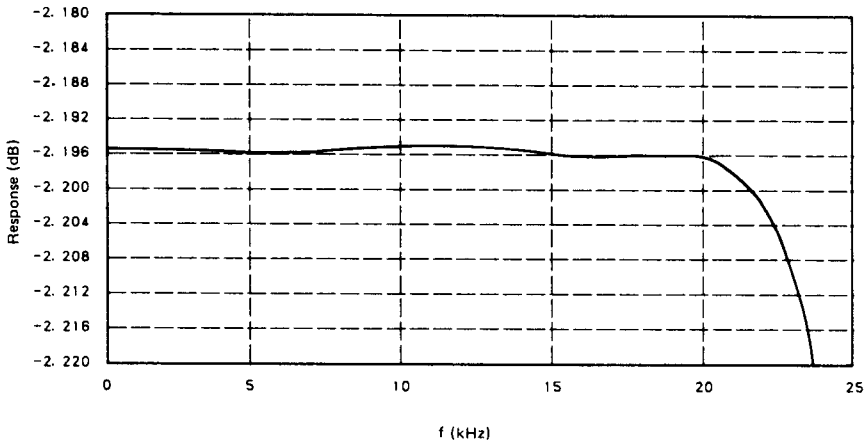

Pass band ripple characteristics

(Excluding frequency characteristics compensation)